

Instruction Manual

Thermal Label Printer

AE240 series

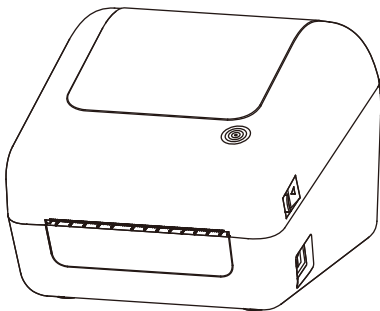

Table of Content

| | |
|---|----|
| 1. Packing List | 1 |
| 2. Appearance and Components | 2 |
| 3. Preparation | 3 |
| 4. Basic Functions | 13 |
| 5. Trouble shooting | 18 |
| 6. Bluetooth connection and usage | 19 |
| 7. Clean the printer | 20 |
| 8. Technical Parameters | 22 |

Preface

About this Manual

This manual contains information about the use and installation of the product. Please read this instruction carefully before using the printer and follow the instructions.

International conventions

For your convenience, the following symbols (ICONS) and conventions are used in this manual:



Warning: This sign warns that improper use may result in property damage, serious injury or death.



Caution: This sign indicates caution. Improper use may cause personal injury or damage to items.



Remarks: This mark represents remarks. The information listed can enable you to better use the product or extend the service life of the product.

1.Packing list

After unpacking the package, check whether the product appearance is intact and check all accessories. If there is any defect, please contact the dealer!

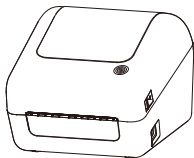

Printer

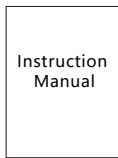

Instruction Manual

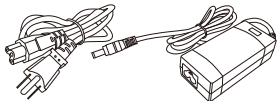

Power Adapter and Cable

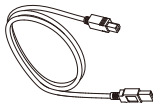

USB Cable



1 Roll Label

Note: due to the continuous improvement of the product, the specifications, accessories and programs described in the manual are subject to real machines, and we reserve the right to change without notice.

2.Appearance and Components

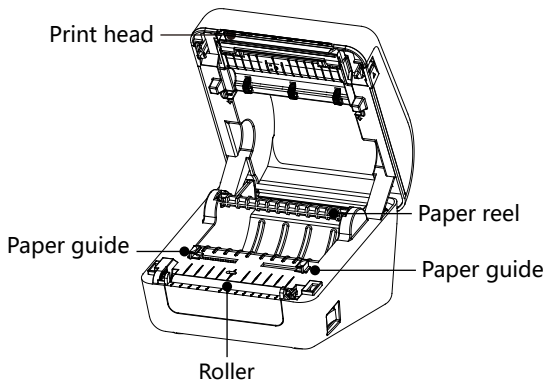
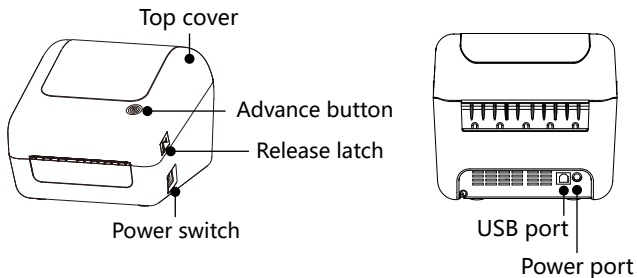

3.Preparation

3.1 Power switch

Turn the printer power switch to I state,  that is, turn on the power switch.

Turn the printer power switch to O state,  that is, turn off the power switch.

- 1) Power must be turned off with a power switch. If the power is turned off by unplugging the power plug, the circuit in the printer will be damaged and the printed data will be destroyed.
- 2) Please use the original power supply of the machine, otherwise the printing quality may be reduced or the printer may be damaged.
- 3) Wait for a certain time ($\geq 5S$) when turning on the power again after the power is turned off. If the power supply is turned on immediately without a certain period of time, faults may occur.
- 4) After the power is turned off, the power lamp on the operation panel will be off after 2-3 seconds. This is a normal condition, not a malfunction.

3.2 Connect the power supply

1) Connect the power cable.

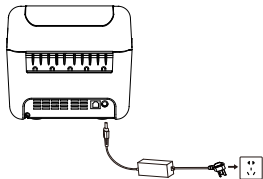

2) Connect the USB cable

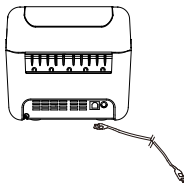

3) Turn on the power

Set the printer power switch to I.



3.3 Install the driver

Please access help.aiyin.com to download and install the driver, as shown below.

3.3.1 Installation for Windows

a. Download exe format driver file. Click to install.

| Name | Date modified |
|--|-----------------|
|  Aiyin_Printer_Driver | 2023/8/25 16:03 |

b. Follow the prompts to complete the installation step by step.

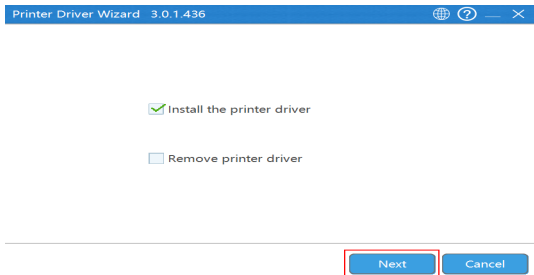

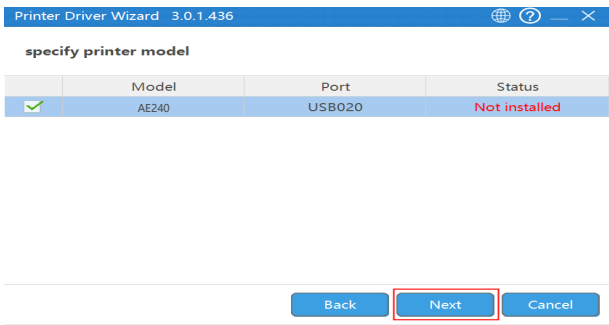
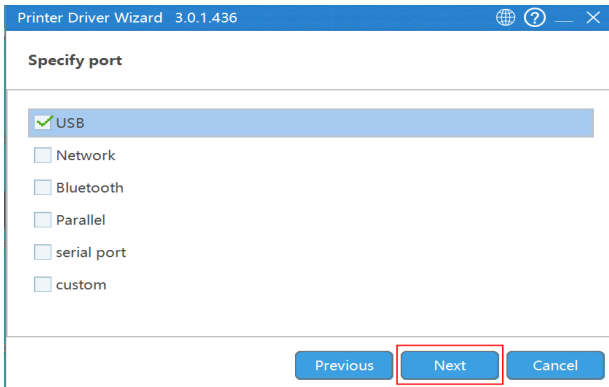

Specify the printer name

Enter printer name

Printer name: Use this printer as default

Previous

Next

Cancel

3.3.2 Installation for Mac

a. Connect power and computer

- 1) Connect the power to the printer through power cord.
- 2) Connect the printer to your computer through USB cord.
- 3) Put the labels in, switch on the printer.

Note:

Make sure these three steps are completed before printing in case failing to install the printer driver.

b. You can download the driver "Driver for Mac (AE240/AE240-bt)" from "help.aiyin.com")



- c. Open "System Preferences", and click on Security & Privacy".
(If you don't see the warning , you can skip this step)

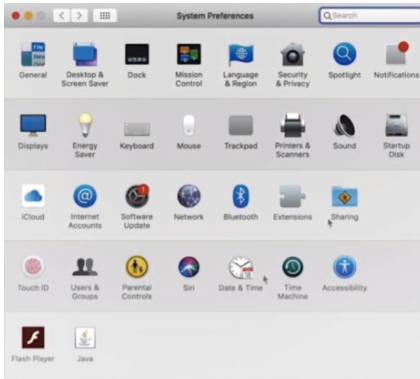

d. Click on "Open Anyway" button. (If you don't see the warning, you can skip this step)

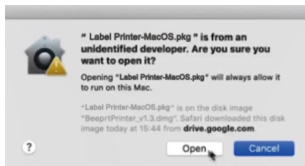
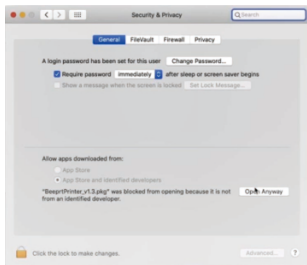

e. Click on open" and continue to install the printer. Follow the installation steps until you see " The installation was successful" window.

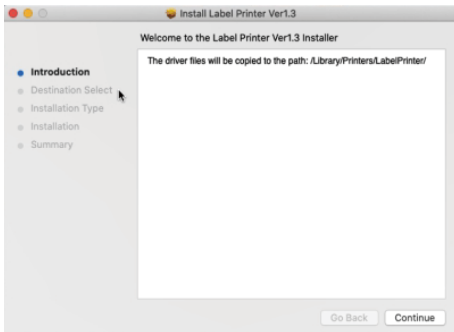

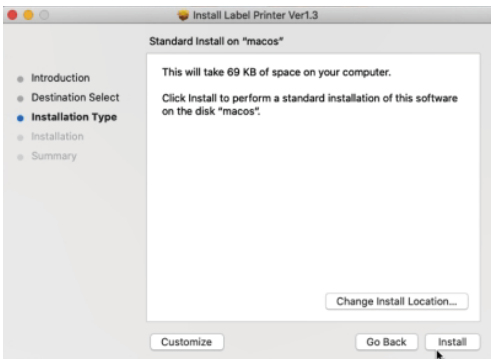
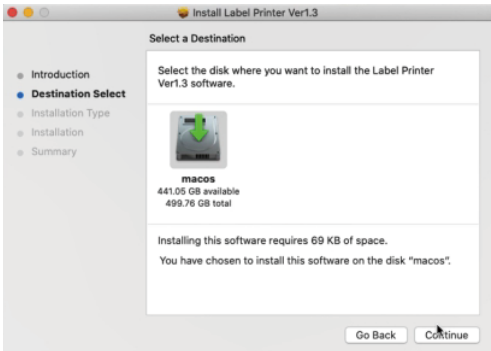

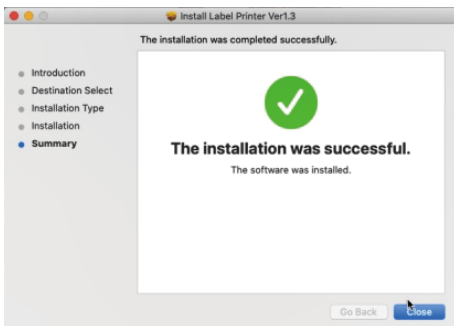

f. Open "System Preferences" >> click on "Printer and Scanners".



g. Click "+" to add a new printer.

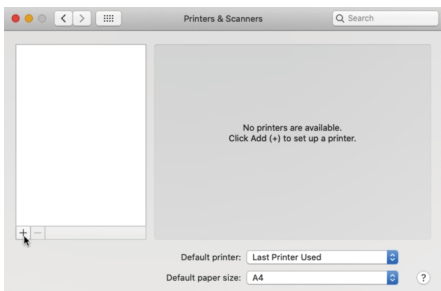

h. Click on Thermal Label Printer, and choose "Select Software" in the drop down menu.

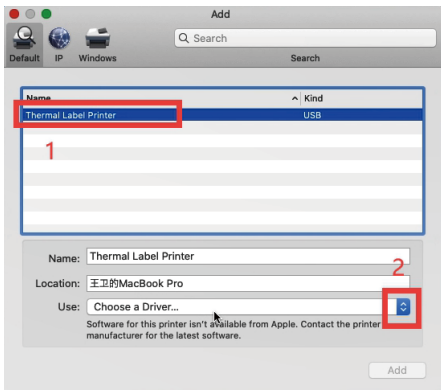

i. Choose "Label Printer", click "OK".

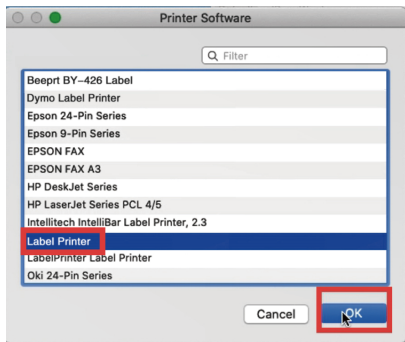

j. Click Add, now the printer has been installed in your Mac book successfully.

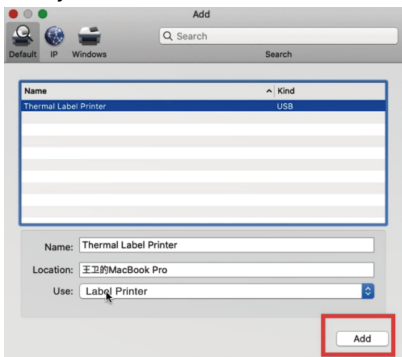

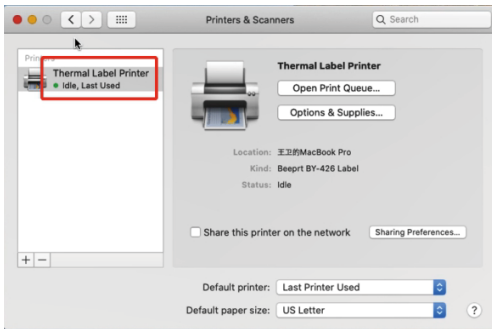

Note:

1. Now you can print directly, if you want to adjust the printing density, printing speed or other parameter, please refer to part 4 Basic Functions".
2. If you can't print successfully, please restart your computer and try again.

4. Basic Functions

The status and fault of the printer can be determined by the color of the button indicators and the buzzer, and the printer can be operated simply by the buttons.

4.1 Paper advance function

Turn on the power of the printer, press the "Advance" button, and the printer will send the paper to the specified location according to the type of paper. When using thermal sensitive paper, press the "Advance" button once to release a whole sheet of paper.

4.2 Intelligent learning of paper

Turn off the power supply of the printer, open the top cover, load the paper and close the top cover, turn on the power switch of the printer, wait until the normal initialization of the printer is completed (about 3-5 seconds), press the "Advance button" and hold it until the "Dee" sound is heard, and the printer can automatically carry out the intelligent learning of the paper.

4.3 Paper loading

Put the roll label in or insert the fan-fold label from outside, adjust the paper guide to fit the width of paper.

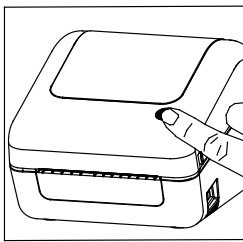
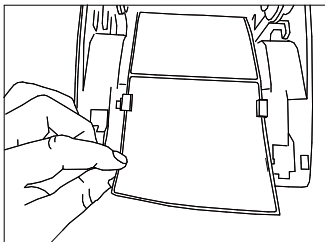

4.4 Print the device self-check page

When the printer is in standby state and the paper is loaded correctly, press the "Advance" button to remove the paper and hold it until "Dee, Dee Dee" is heard, and then the printer can print the self-check page of the device.

"Setting" → select print → "Manage" → "Print a test page"

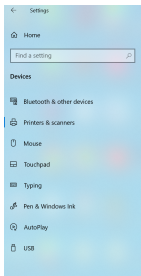

Printers & scanners

Add printers & scanners

+ Add a printer or scanner

Printers & scanners

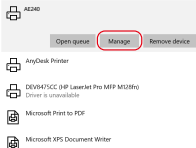

Settings

AE240

Manage your device

Printer status: Idle

Open print queue

Set as default

Print a test page

Run the troubleshooter

Printer properties

Printing preferences

Hardware properties

Note:

Before printing a test page, please check that your printer has drivers and labels installed.

4.5 Adjust the print grayscale

Note: If your printer content is not clear, you can set the print grayscale to "none".

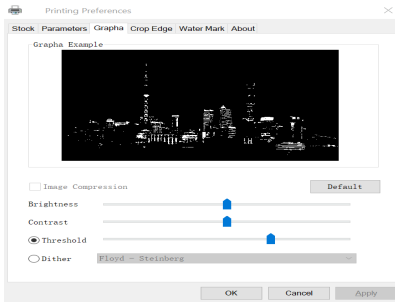

4.6 Adjust printer speed and print density

Note:

If you need to adjust the printing speed and printing density, you can adjust it here.

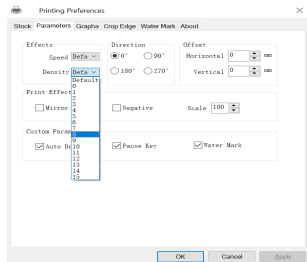
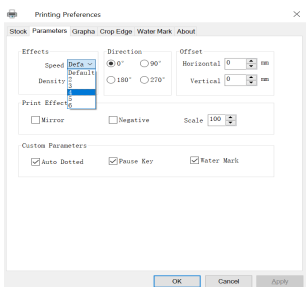
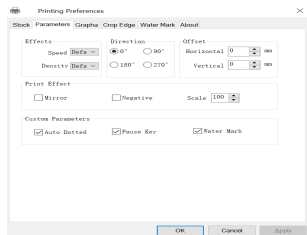

4.7 Adjust the paper size:

Note:

If you need to create a new paper size, you can do so here.
Page" → "Paper" → "Paper Manage"

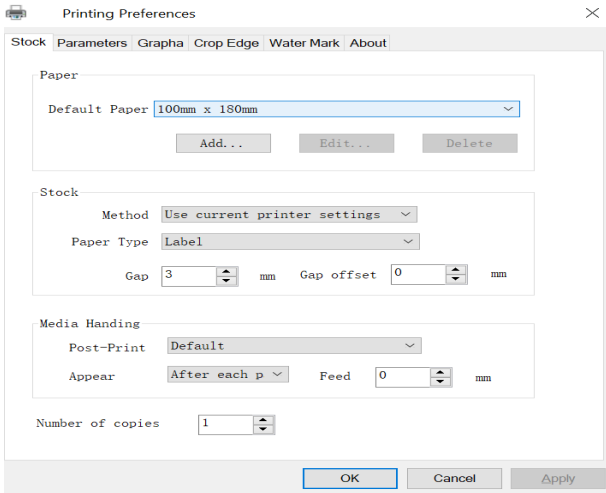

5.Trouble shooting

| Indicator light | Status | Trouble shooting |
|---|---------------------------|--|
| Green | The Printer is normal | |
| Flashing alternately red and green | Print head overheating | Wait for the printer to cool down and continue working automatically. Note ① |
| Red flashing slowly (Once every 2 seconds) | Paper error Lack of paper | Make sure there is no paper adhesion or paper jam. Note①② Make sure the printer loads the paper correctly. Note①② Perform automatic intelligent label learning. |
| Red flashing quickly (Twice a second) | Top cover not closed | Check that top cover is closed completely |

Note:

①These faults can be eliminated without shutting down the printer. After trouble shooting, the printer can continue to work automatically without causing the loss of printing content.

②Check the faults in sequence. If the previous fault can not be removed, perform the next operation.

6. Bluetooth connection and usage

Note: It is suitable for devices with Bluetooth.

6.1 How to use it in Android phones:

Step 1: Turn on the printer power;

Step 2: Search the mobile phone on the Bluetooth interface, then click the printer to connect, input the PIN code "0000" or "1234" to complete the pairing;

Step 3: Open the corresponding APP and select the printer that has been paired from the device list.

6.2 How to use it in iPhone:

Step 1: Turn on Bluetooth and printer power

Step 2: Open the corresponding APP and select the printer that has been paired from the device list.

6.3 We recommend the APP:

"Label expert" . You can download it on Google Play Store and APP Store. Or you can scan the QR code below to download the APP.



iOS users scan this code to download



Android users scan this code to download

Remark:

1. It is suitable for devices with Bluetooth.
2. The Bluetooth of the mobile phone shall be turned on during the above connection process.
3. IOS devices can use APP to connect without PIN-code pairing.

7.Clean the printer

Dust, foreign matter, sticky matter, or other contaminants sticking to the print head or printer may degrade print quality. If it's contaminated, please clean the print head as follows.



Matters needing attention:

- 1) Turn off the power supply of the printer before cleaning.
- 2) The print head gets very hot when printing. Therefore, if you want to clean the print head, turn off the printer power and wait 2 to 3 minutes before starting.
- 3) When cleaning the print head, do not touch the heating part of the print head, so as not to damage the print head due to static electricity.
- 4) Be careful not to scratch or damage the print head.

7.1 Cleaning the Printer

- 1) Please open the top cover and use a Clean Pen (or a cotton swab dipped in diluted alcohol (alcohol or isopropyl alcohol)) to clean the top cover from the middle of the print head to both sides.
- 2) After cleaning the print head, do not use the printer immediately. Wait until the clean alcohol used is completely volatilized (1 to 2 minutes) and the print head is completely dry before use.

7.2 Clean sensor, rubber roll and paper path

- 1) Please open the top cover of the printer and take out the paper roll.
- 2) Use a dry cotton cloth or cotton swab to wipe away dust or foreign matter.

- 3) Soak a cotton cloth or cotton swab in medical alcohol and use it to wipe away sticky foreign matter or other contaminants.
- 4) Do not use the printer immediately after cleaning the parts. Before using it, please wait for alcohol evaporating completely (1 to 2 minutes) and the printer drying completely.

Note: Clean parts when print quality or paper test performance deteriorates.

8. Technical Parameters

| Method | Thermal |
|-----------------------|---|
| Printing Speed | 150mm/s |
| Paper width | 40-110mm |
| Paper Thickness | 0.08-0.2mm |
| Supported Paper | Thermal Label Paper |
| Power adapter | 24V/2.0A |
| Printing life | TPH 30km |
| Connection | USB or USB+Bluetooth |
| Operating Environment | Temperature: 5-40°C Humidity: 20-90% |
| Storage Environment | Temperature: -25-55°C Humidity: 20-93% |
| Dimension | 205*175*150mm |

Warranty Card

Dear Customer:

Thank you for purchasing our products. In order to protect your legal rights, relieve your worries, and improve customer after-sales service, we've specially formulated a warranty policy. Please read it carefully and provide us your valuable opinions and suggestions.

Warranty

1. The machine warranty period of this product is 1 year, as for the printing head is 3 months or 30km (whichever comes first). From the received date of the goods, if the failure is caused by the material or process of the product itself, the corresponding certificate/receipt shall be provided for free repair or replacement.
2. Warranty service can only be performed by our company or authorized service providers, and any unauthorized repair or replacement of parts will invalidate the warranty.
3. Users need to follow the manual guide for equipment installation and other operations. If the equipment hardware is damaged due to improper use by the customer, the warranty will not be granted.
4. This warranty does not cover damage caused by natural disasters such as fire disaster, lightning or other similar reasons.
5. The company reserves the right of having concluding statement.

Customer notice

1. Please specify the reason for the product return in detail.
2. Please contact customer service before returning for repair.
3. We do not accept any form of express delivery.

| | |
|-------------------|--|
| Model | |
| Serial Number | |
| Customer Name | |
| Date of purchased | |
| Shop name | |
| Phone number | |

Kad Waranti

Terima kasih kerana membeli produk kami. Untuk melindungi hak undang-undang anda, melegakan kebimbangan anda dan menambah baik perkhidmatan selepas jualan pelanggan, kami telah merumuskan dasar jaminan secara khusus. Sila baca dengan teliti dan berikan kami pendapat dan cadangan anda yang berharga.

Waranti

1. Tempoh jaminan mesin produk ini adalah 1 tahun, manakala kepala cetakan adalah 3 bulan atau 30km (mana yang lebih awal). Dari tarikh diterima barang, jika kegagalan disebabkan oleh bahan atau proses produk itu sendiri, sijil/resit yang sepadan hendaklah diberikan untuk pembaikan atau penggantian percuma.
2. Perkhidmatan waranti hanya boleh dilakukan oleh syarikat kami atau pembekal perkhidmatan yang dibenarkan, dan sebarang pembaikan atau penggantian alat ganti yang tidak dibenarkan akan membatalkan waranti.
3. Pengguna perlu mengikut panduan manual untuk pemasangan peralatan dan operasi lain. Jika perkakasan peralatan rosak akibat penggunaan yang tidak wajar oleh pelanggan, waranti tidak akan diberikan.
4. Waranti ini tidak melindungi kerosakan yang disebabkan oleh bencana alam seperti bencana kebakaran, petir atau sebab lain yang serupa.

Notis pelanggan

1. Sila nyatakan sebab pemulangan produk secara terperinci.
2. Sila hubungi khidmat pelanggan sebelum kembali untuk pembaikan.
3. Kami tidak menerima sebarang bentuk penghantaran ekspres.

| | |
|-----------------|--|
| Model | |
| Nombor siri | |
| Nama Pelanggan | |
| Tarikh dibeli | |
| nama kedai | |
| notis pelanggan | |



Find out more product knowledge
and after-sales service

Xiamen AiYin Technology Co., Ltd.

Index: www.aiyin.com

Driver: help.aiyin.com

E-mail: support@aiyin.com